

HOLYROOD CLOSE

Serviced Office Space to Rent in Poole



arenaoffices.com

📞 0330 1246598



Arena Poole: Holyrood Close

📍 Holyrood Close, Poole, BH17 7FJ

Arena Poole delivers a wealth of flexible, thoughtfully-designed workspace for entrepreneurs, SMEs and Corporates within this thriving region.

Businesses can benefit from a vibrant business community, bright business lounge and professional meeting rooms to give space away from the office to create, collaborate and share.



Emma Mitchell
Centre manager

Why Holyrood Close?

- Spacious, purpose-built business centre nestled within mature landscaped gardens.
- Contemporary office suites & multi-purpose studios from 2 to 100 desks.
- Interior designed collaboration space with lounge areas for the exclusive use of our clients.
- Beautiful meeting rooms with the latest state of the art technology & AV designed for innovation.
- Prime location with on-site artisan café. Excellent road links to the A35.
- A vibrant, inspiring & exclusive working environment for clients & their teams to belong to.





Work Spaces

Now more than ever we understand the need for our clients to stay agile, keep flexible and control their costs. We will take the time to work with every business to ensure they have the right type of space to thrive in a risk free environment where they can fully focus on success.

Collaboration Spaces & Meeting Rooms

With a collection of professional meeting rooms, they create space away from your office to engage with the team, collaborate together and generate your best ideas.





Choose your Workspace

3-10 Desks

Let us help you make a smart move. Whether you are looking to make the next step away from homeworking, find a 5 desk workspace or create a new satellite office we will work consultatively to find the best solution for your business. The range of sizes within this category enable clients to flex the workspace on their terms.

10-20 Desks

With short terms agreements and a single monthly fee our focus is in creating complete flexibility and agility so our clients can focus on success. The range of workspaces within this category delivers freedom for companies to scale the business on their terms.

Customising your space

We understand the importance of making the right move, so we help every step of the way. Using our knowledge we work with clients to create a space that truly works for them utilising every sq ft cost effectively. Whether that's creating meeting areas, accommodating a server room or making single offices – we recognise every client is unique.

A bespoke design service

Great design is at the heart of every Arena, so we make sure our office space is too. We collaborate with the best in the industry to deliver a design service for our clients that will inspire new ways to use their space creatively, collaboratively and considerately.

Safe Working Environments

Arena are committed to providing safe and flexible office environments that allow our clients to work with confidence and ease. Our priority now more than ever is to deliver safe, flexible office space that enables our clients to stay agile and adapt to an ever-changing landscape.





A Block Ground Floor

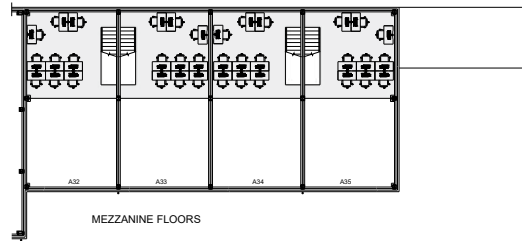

A Block First Floor

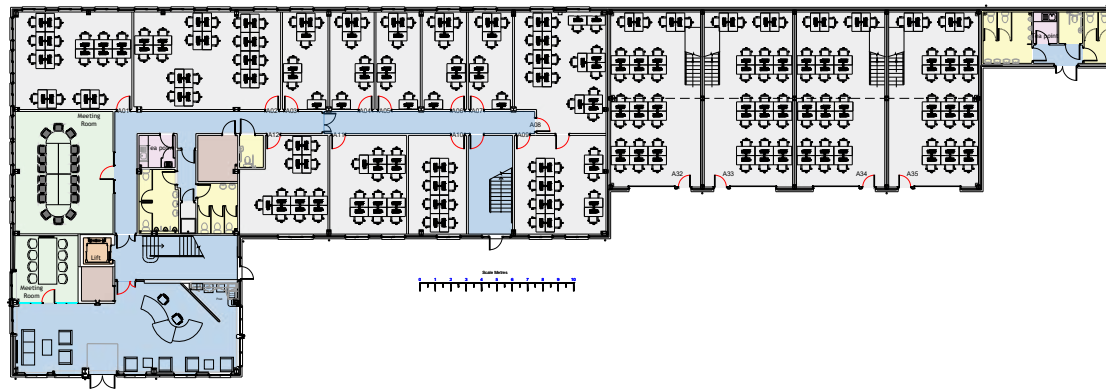
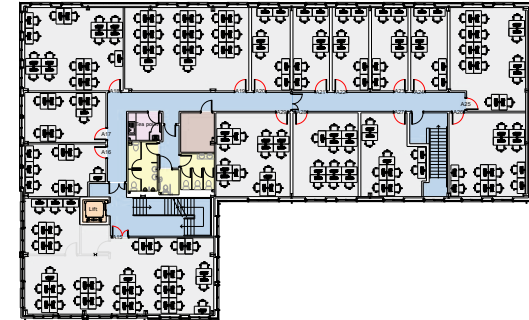

A Block Second Floor

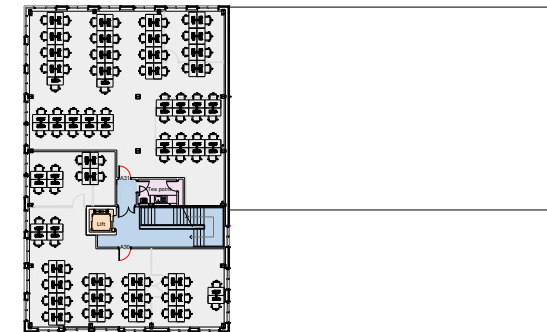

Floor Plans

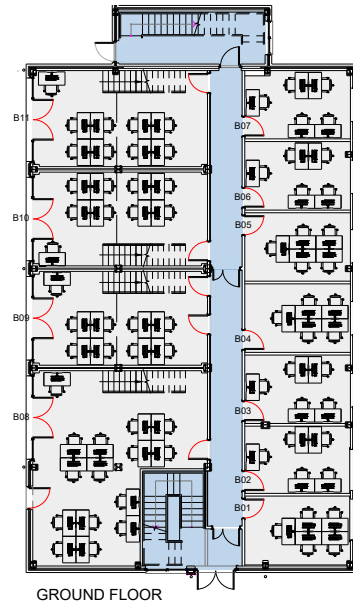

GROUND FLOOR

B Block Ground Floor

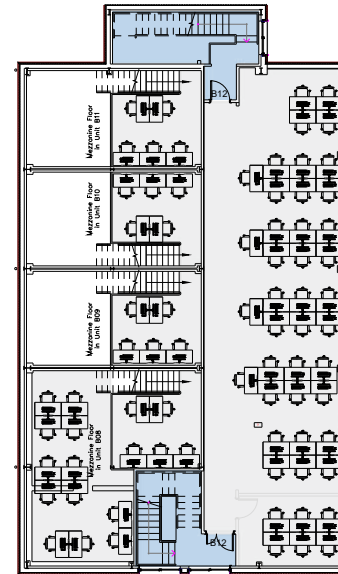

FIRST AND MEZZANINE FLOORS

B Block First Floor

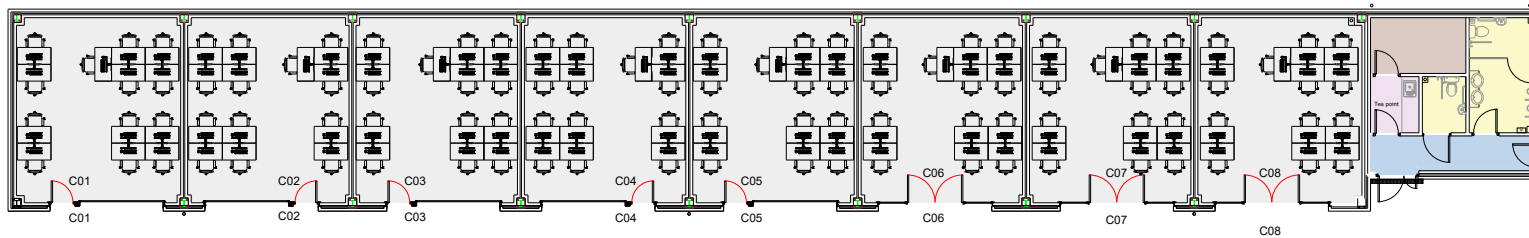

C Block

D Block

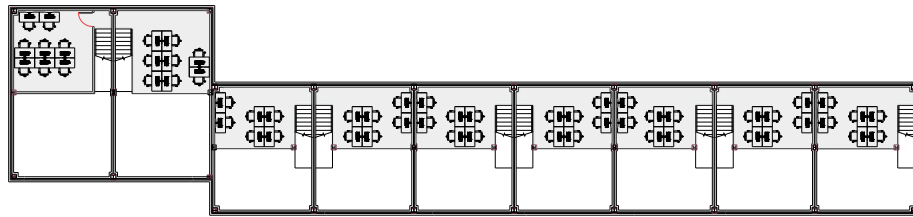

MEZZANINE FLOORS

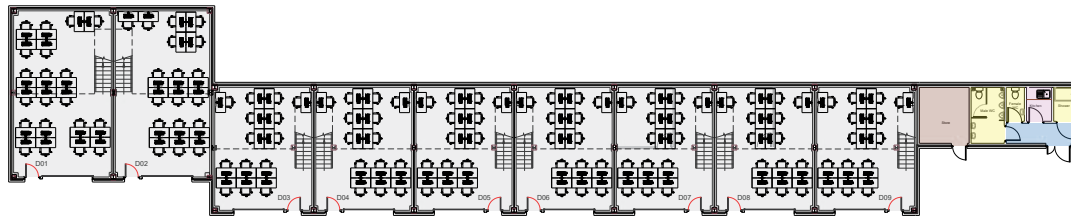

GROUND FLOOR

E Block

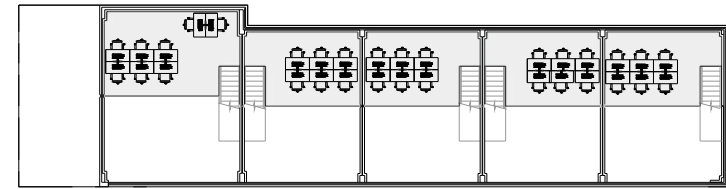

MEZZANINE FLOORS

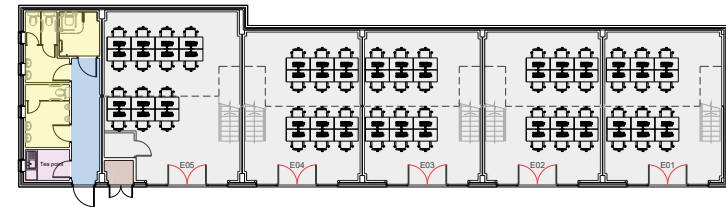

GROUND FLOOR

F Block

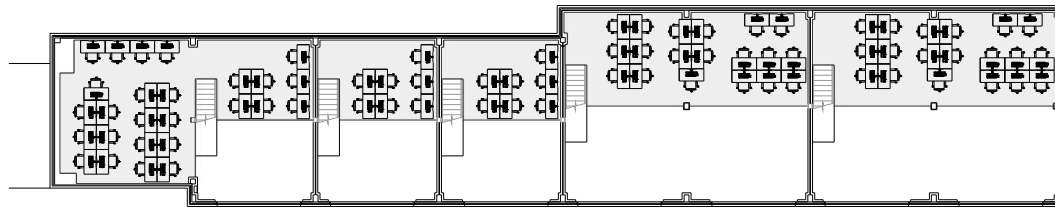

MEZZANINE FLOORS

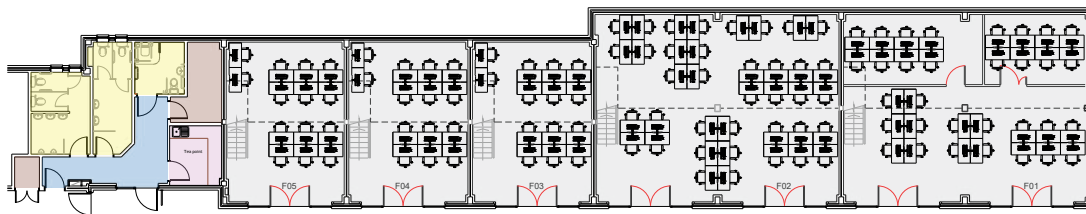

GROUND FLOOR

G Block

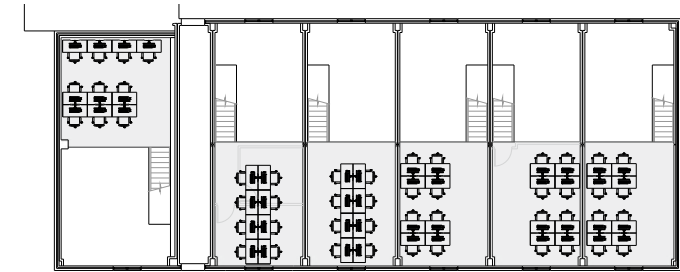

MEZZANINE FLOORS

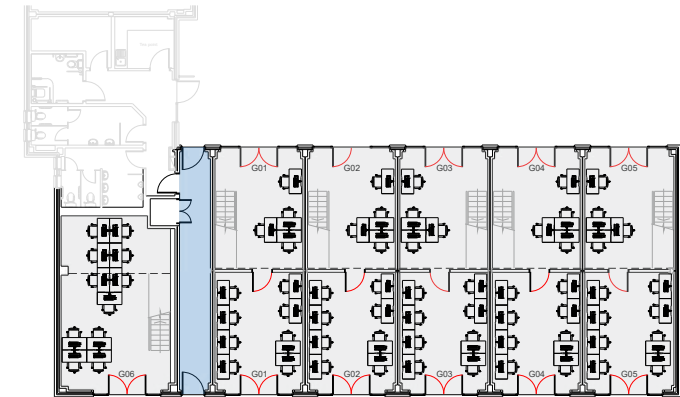



GROUND FLOOR



Poole: Holyrood Close

Located close to Poole Harbour, this business centre benefits from an excellent central location. This centre is located within a 10 minute drive from Poole train station with frequent, direct services to London Waterloo. The centre is within a 25 minute drive from Bournemouth airport and in close proximity to the A31 and A350, providing great access for a simple commute.

-
-  **Rail:** Poole Station (2 Miles)
 -  **Road:** A31 (4 Miles)
 -  **Air:** Bournemouth (10 Miles)



Holyrood Close

📍 Holyrood Close, Poole, BH17 7FJ

Visit - [Arenaoffices.com](https://arenaoffices.com)

Call - 0330 1246598

Email - hello@arenaoffices.com

